



# GP 645

## 6V 4.5Ah

GP 645 is a general purpose battery up to 5 years in standby service or more than 260 cycles at 100% discharge in cycle service. As with all CSB batteries, all are rechargeable, highly efficient, leak proof and maintenance free.



### Specification

<b>Cells Per Unit</b>	3
<b>Voltage Per Unit</b>	6
<b>Capacity</b>	4.5Ah @ 20hr-rate to 1.75V per cell @25 °C(77°F)
<b>Weight</b>	Approx. 0.84 kg(1.85 lbs)
<b>Maximum Discharge Current</b>	60A/90A(5sec)
<b>Internal Resistance</b>	Approx. 19 mΩ
<b>Operating Temperature Range</b>	Discharge: -15°C~50°C ( 5°F~122°F) Charge: -15 °C~40°C ( 5°F~104°F) Storage: -15°C~40°C ( 5°F~104°F)
<b>Nominal Operating Temperature Range</b>	25°C±3°C(77°F±5°F)
<b>Float Charging Voltage</b>	6.75 to 6.9 VDC/unit Average at 25°C(77°F)
<b>Recommended Maximum Charging</b>	1.35A
<b>Current Limit</b>	
<b>Equalization and Cycle Service</b>	7.2 to 7.5 VDC/unit Average at 25°C(77°F)
<b>Self Discharge</b>	CSB Batteries can be stored for more than 6 months at 25°C(77°F). Please charge batteries before using. For higher temperatures the time interval will be shorter.
<b>Terminal</b>	F1/F2-Faston Tab187/250
<b>Container Material</b>	ABS(UL 94-HB/File E50263)*Flammability resistance of (UL 94-V0/File E88637) can be available upon request.



MH14533(N)



ISO9001  
No :041005117



ISO 14001  
NO.UM 1-12-0045

CSB-manufactured batteries are UL-recognized components under UL924 and UL1989. CSB is also certified by ISO 9001 and ISO 14001.

### Dimensions

unit:(MM)

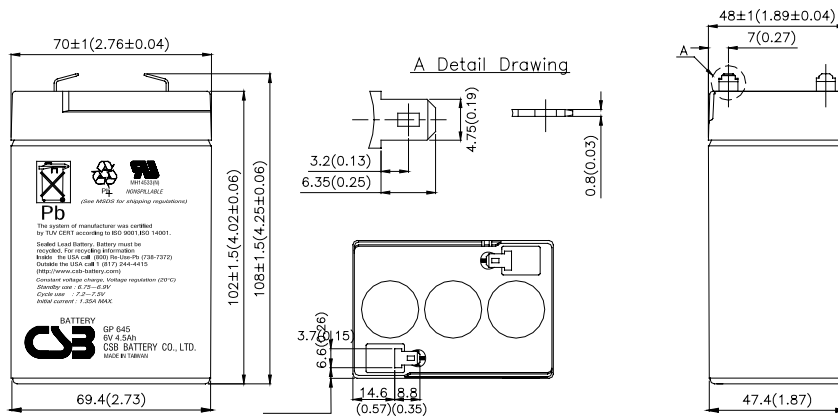

### Constant Current Discharge Characteristics Unit:A (25°C,77°F)

F.V/Time	5MIN	10MIN	15MIN	30MIN	1HR	2HR	3HR	4HR	5HR	8HR	10HR	20HR
1.60V	18.7	12.3	9.08	5.37	3.11	1.80	1.26	0.994	0.810	0.535	0.439	0.234
1.67V	17.6	11.8	8.89	5.31	3.10	1.79	1.25	0.987	0.808	0.533	0.438	0.233
1.70V	17.0	11.6	8.79	5.28	3.08	1.78	1.24	0.984	0.807	0.532	0.437	0.232
1.75V	16.1	11.2	8.62	5.22	3.06	1.77	1.23	0.979	0.804	0.531	0.435	0.229
1.80V	15.0	10.7	8.42	5.13	3.03	1.76	1.22	0.975	0.801	0.529	0.431	0.225
1.85V	13.8	10.3	8.22	5.05	3.00	1.75	1.21	0.971	0.798	0.528	0.428	0.221

### Constant Power Discharge Characteristics Unit:W (25°C,77°F)

F.V/Time	5MIN	10MIN	15MIN	30MIN	1HR	2HR	3HR	4HR	5HR	8HR	10HR	20HR
1.60V	112	73.5	54.5	32.2	18.7	10.8	7.55	5.96	4.86	3.21	2.64	1.41
1.67V	105	70.4	53.4	31.8	18.6	10.7	7.52	5.94	4.85	3.20	2.63	1.40
1.70V	102	69.2	52.7	31.6	18.5	10.6	7.50	5.93	4.84	3.19	2.62	1.39
1.75V	96.0	66.8	51.8	31.3	18.4	10.5	7.48	5.91	4.83	3.18	2.61	1.38
1.80V	90.0	64.0	50.5	30.8	18.2	10.4	7.45	5.89	4.81	3.17	2.59	1.35
1.85V	82.5	61.3	49.3	30.3	18.0	10.3	7.43	5.87	4.80	3.16	2.57	1.33

● All mentioned values are average values.

### Trickle (or Float) Service Life

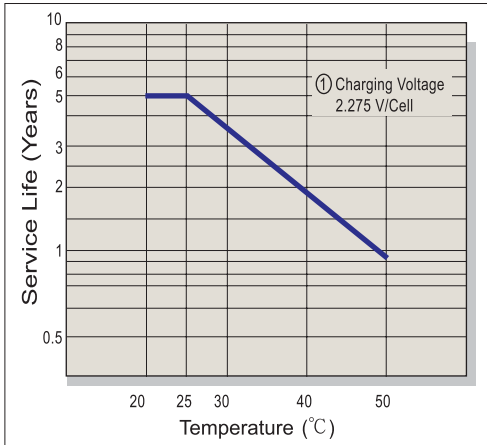

### Capacity Retention Characteristic

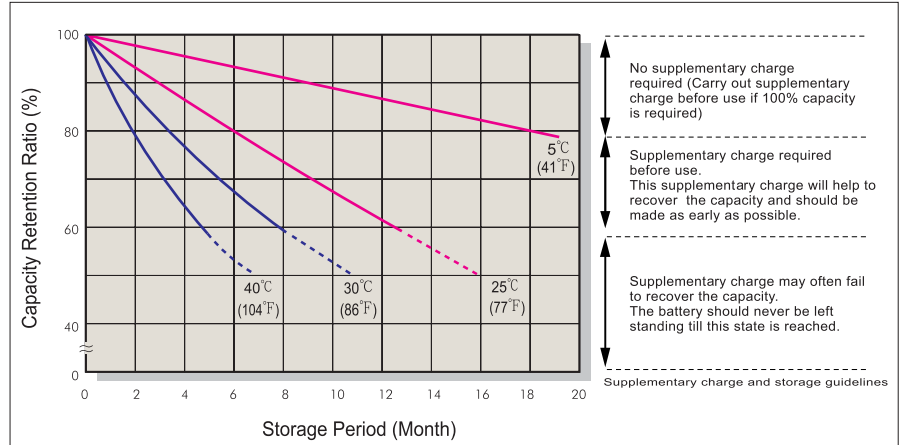

### Battery Voltage and Charge Time for Standby Use

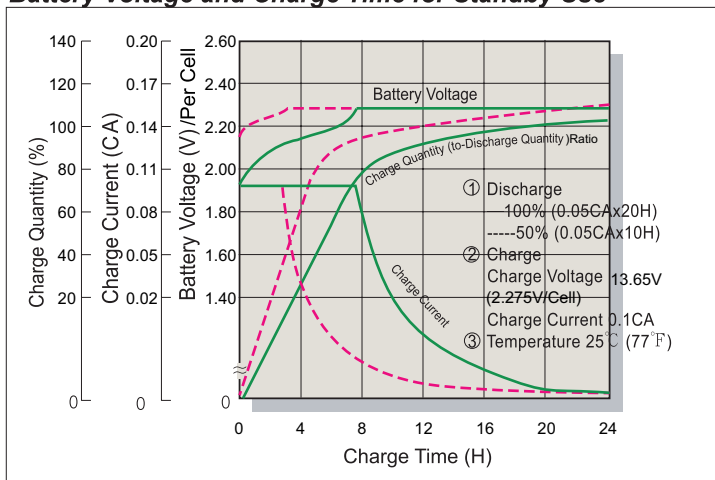

### Cycle Service Life

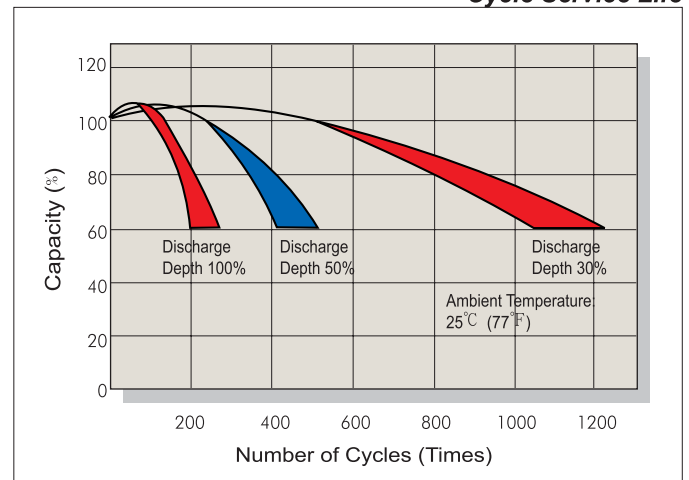

### Battery Voltage and Charge Time for Cycle Use

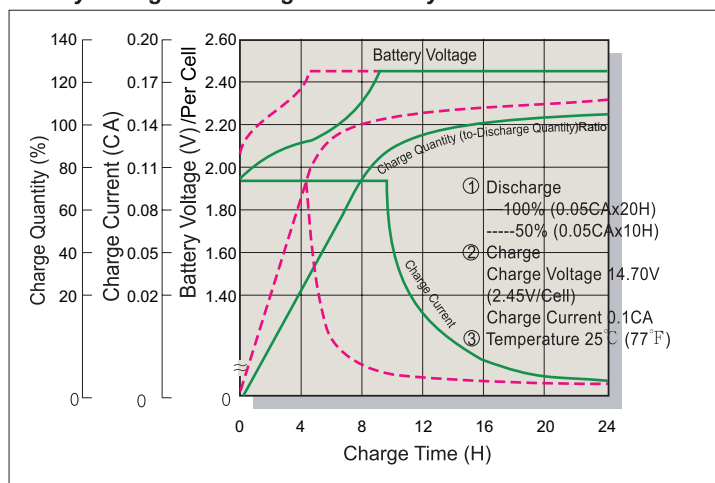

### Terminal Voltage (V) and Discharge Time

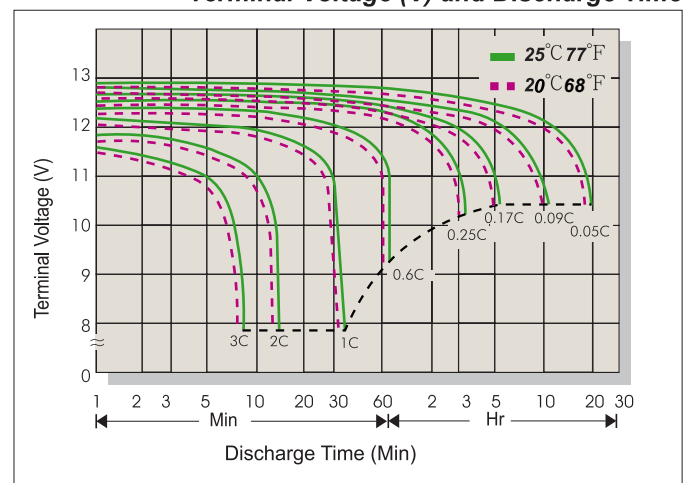

### Charging Procedures

Application	Charge Voltage(V/Cell)			Max.Charge Current
	Temperature	Set Point	Allowable Range	
Cycle Use	25°C (77°F)	2.45	2.40~2.50	0.3C
Standby	25°C (77°F)	2.275	2.25~2.30	

### Discharge Current VS. Discharge Voltage

Final Discharge Voltage V/Cell	1.75	1.70	1.60	1.30
Discharge Current(A)	0.2C>(A)	0.2C<(A)<0.5C	0.5C<(A)<1.0C	(A)>1.0C

Sales Office URL: [WWW.CSB-BATTERY.COM](http://WWW.CSB-BATTERY.COM)

**CSB BATTERY CO., LTD.**  
 TAIWAN OFFICE  
 Tel: +886-2-2555-5600  
 Fax: +886-2-2555-3300  
 E-mail: service@csb-battery.com.tw

**CSB BATTERY LOGISTICS (SHANGHAI) CO., LTD.**  
 SHANGHAI OFFICE  
 Tel: +86-21-5046-1622, 5046-0833  
 Fax: +86-21-5064-3314

**CSB BATTERY TECHNOLOGIES, INC**  
 USA OFFICE  
 Tel: +1-817-244-7777/1-8003 CSBUSA(272872)  
 Fax: +1-817-244-4445  
 E-mail: csb@csb-battery.com

**CSB BATTERY LOGISTICS (SHANGHAI) CO., LTD.**  
 BEIJING OFFICE  
 Tel: +86-10-6597-8060, 6597-8070  
 Fax: +86-10-6597-8050  
 E-mail: chinasl@csb-battery.com

**CSB BATTERY OF NETHERLANDS B.V**  
 NETHERLANDS OFFICE  
 Tel: +31(0) 180 418 140  
 Fax: +31(0) 180 418 327  
 E-mail: eurosales@csb-battery.com

**CSB BATTERY LOGISTICS (SHANGHAI) CO., LTD.**  
 SHENZHEN OFFICE  
 Tel: +86-755-2694-2788/2606/2706  
 Fax: +86-755-2694-2748  
 E-mail: she@csb-battery.com.tw